



# Energiecafé Hapert

# Ventilatie in bestaande woningen

24 maart 2026

***“THINK GLOBAL, ACT LOCAL”***

# Agenda

---



- **Voorstellen**
  - Peter den Breeijen,
  - Ad van de Ven,
  - Beiden energieguids
- **Waarom ventileren**
- **Hoe ventileren**
- **Ventilatiesystemen in bestaande woningen**
- **Ventilatieproject**

- **Baas over eigen energie**
- **Mensen helpen bij energietransitie**
- **Energiebesparing**
- **Duurzame energieopwekking**
- **Informatie geven; EnergieLoketten**
- **Energiegidsen; onafhankelijk; energiescans**
- **Coöperatieve aanpak; ZonopdeKempen; KempenStroom;**
- **Energiegemeenschap; energie delen**

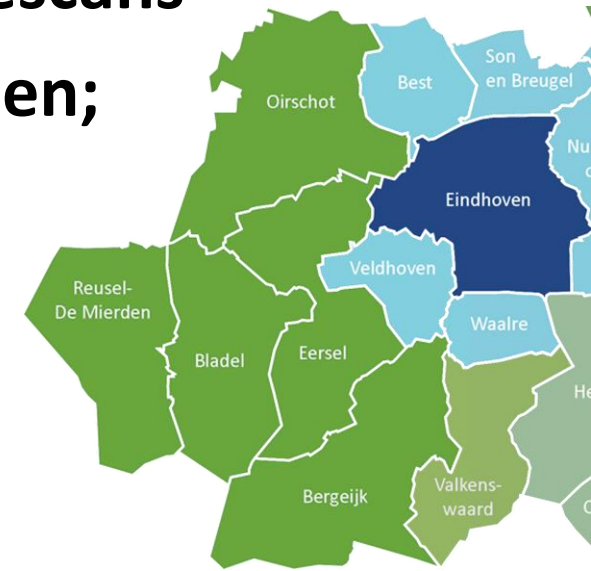

# Waarom

---



# Waarom

- **Gezondheid**
- **Voorkomen van schimmel**
- **Afvoer van ongezonde stoffen + geuren**
- **Noodzaak in goed geïsoleerde huizen**
- **Energiebesparing**

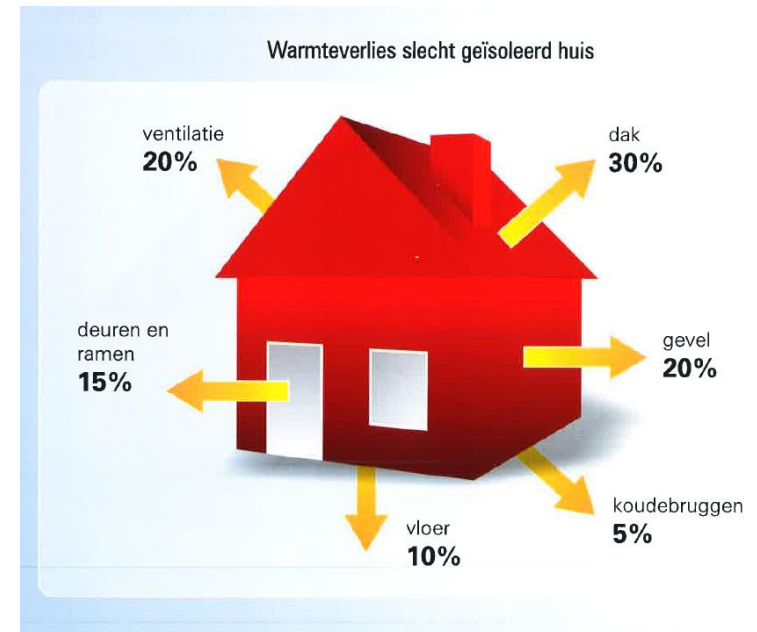

# Hoe ventileren

---

- Lucht verversen
- Afvoer en toevoer
- 35 tot 50 m<sup>3</sup> per persoon per uur
- “Luchten” is geen ventileren
- Gedrag en installatie



# Hoe ventileren

---

**Meten is weten. CO<sub>2</sub> als indicatie:**

- **Buiten: ca. 450 ppm**
- **Binnen goed: tot 800 ppm**
- **Twijfelachtig: tot 1200 ppm**
- **Slecht: meer dan 1200 ppm**



# Ventilatie

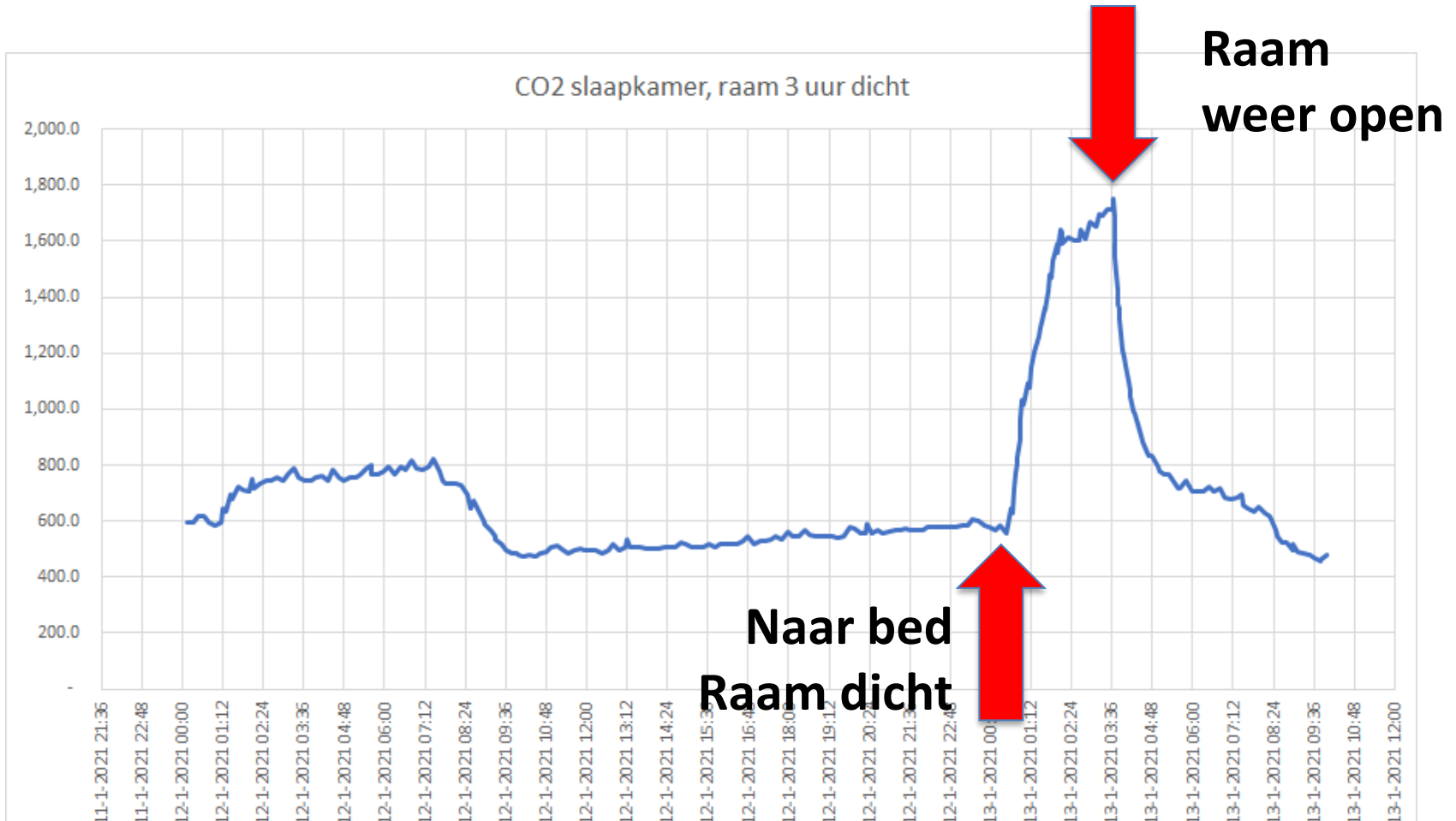

# Hoe ventileren



Meten is weten



# Hoe ventileren

---



## Normen:

### Bouwbesluit eisen luchtverversing voor woonfuncties

ruimte	Eis [ $\text{dm}^3/\text{h}$ ]	eis [ $\text{m}^3/\text{h}$ ]
verblijfsgebied	0,9 $\text{dm}^3/\text{s}$ x vloeroppervlakte, minimaal 7 $\text{dm}^3/\text{s}$	minimaal 25 $\text{m}^3/\text{h}$
verblijfsruimte	0,7 $\text{dm}^3/\text{s}$ x vloeroppervlakte, minimaal 7 $\text{dm}^3/\text{s}$	minimaal 25 $\text{m}^3/\text{h}$
toilet ruimte	7 $\text{dm}^3/\text{s}$	25 $\text{m}^3/\text{h}$
badruimte	14 $\text{dm}^3/\text{s}$	50 $\text{m}^3/\text{h}$
vg/vr met kooktoestel	21 $\text{dm}^3/\text{s}$	75 $\text{m}^3/\text{h}$

# Hoe ventileren

## Relatieve Vochtigheid als indicatie:

- Droog < 40%
- Goed > 40% < 70%
- Te vochtig > 70%



# Hoe luchten/spuien

## Tegen elkaar open zetten

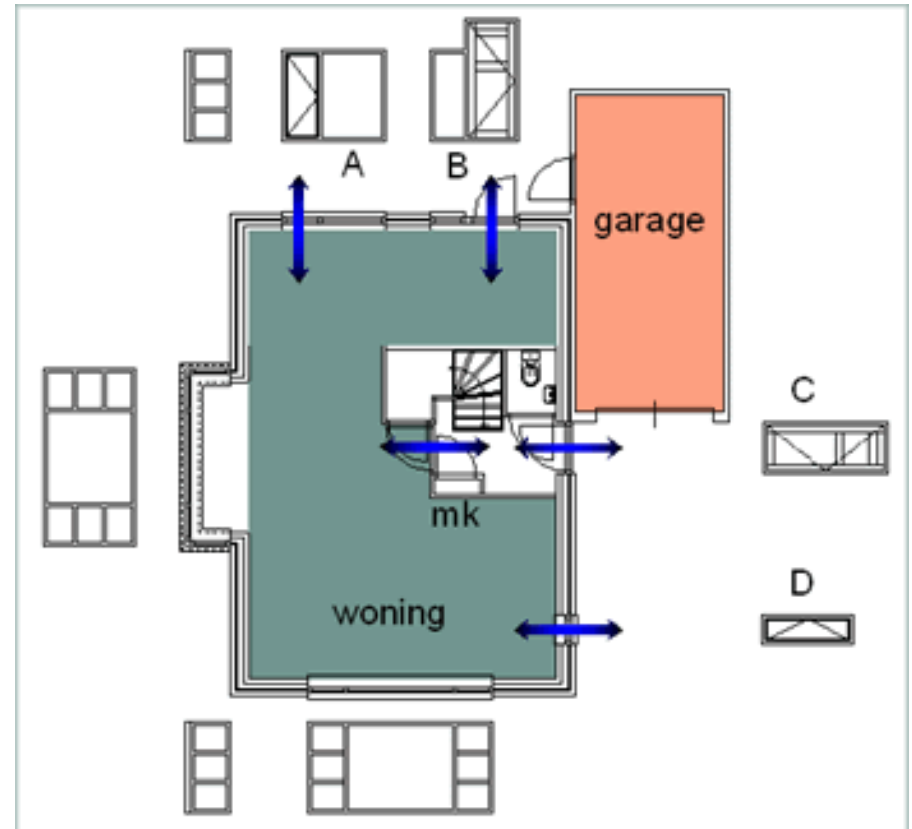

# Hoe ventileren

---

- **continu proces**
- **als er personen aanwezig zijn**
- **afvoer en toevoer**
- **CO2 of RV als indicator**
- **beperken energieverliezen**
- **zonder comfortproblemen**

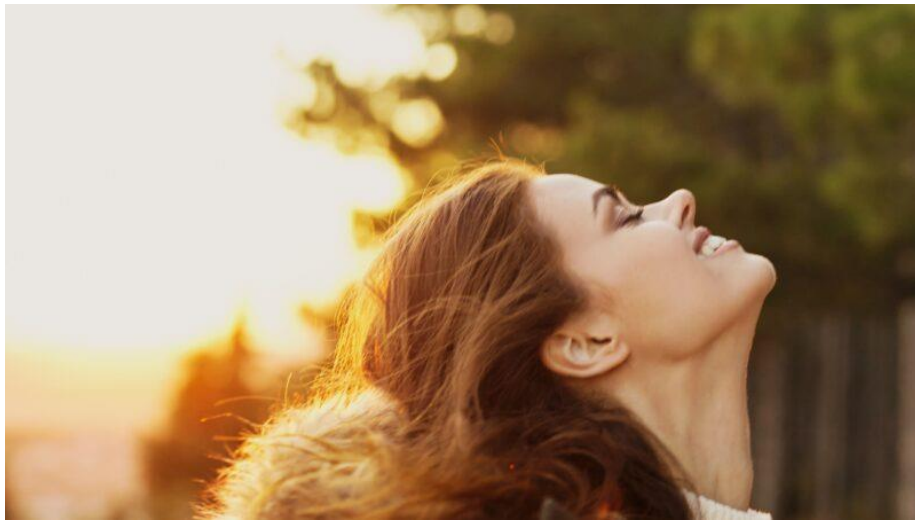

# Hoe ventileren

Lucht moet door de woning kunnen stromen

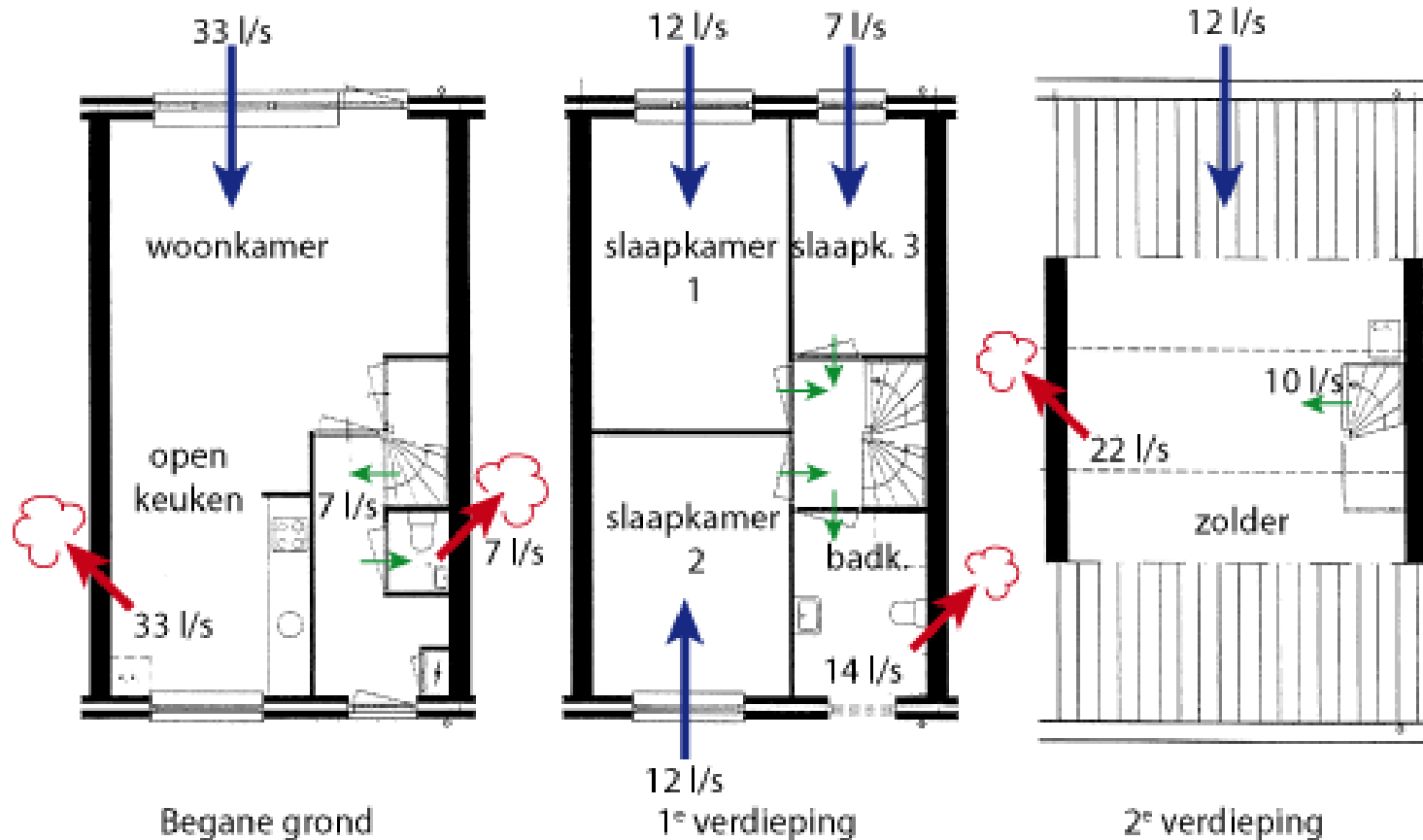

# Hoe ventileren

## Lucht moet door de woning kunnen stromen

A. Natuurlijke toevoer en mechanische afvoer (systeem C volgens de norm)

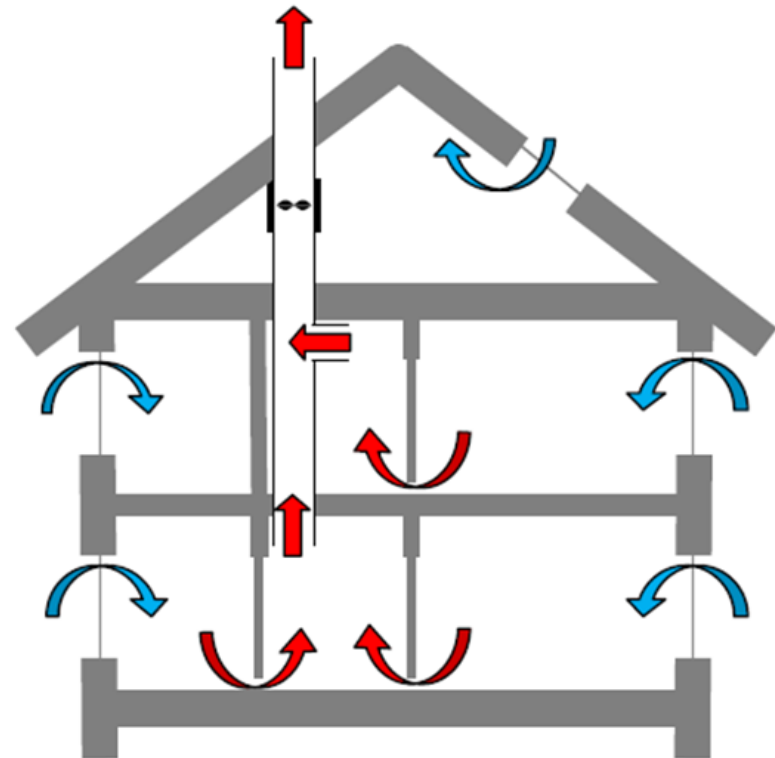
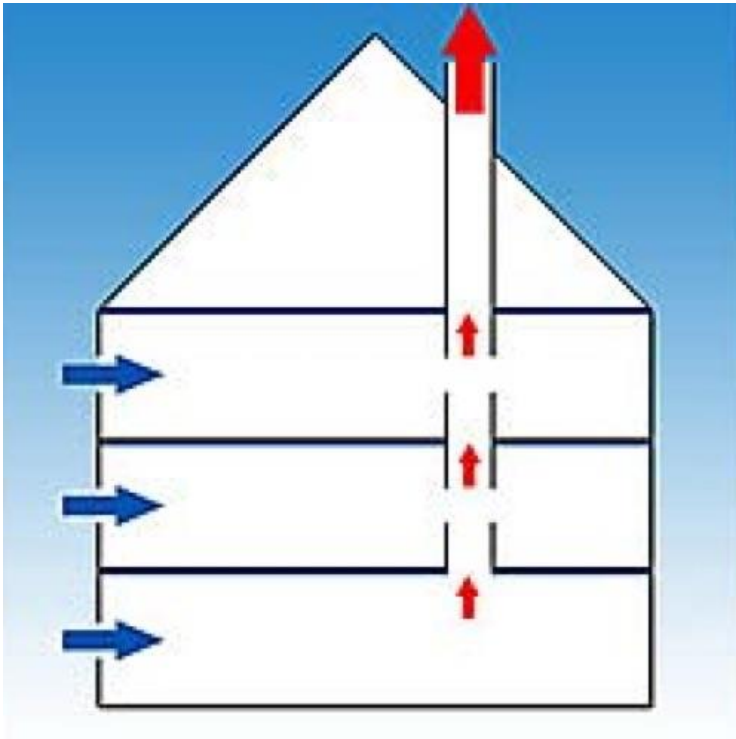

# Hoe ventileren

## 3 systemen:

- **Natuurlijk**
- **Natuurlijk + mechanisch (hybride)**
- **Mechanisch (balansventilatie)**

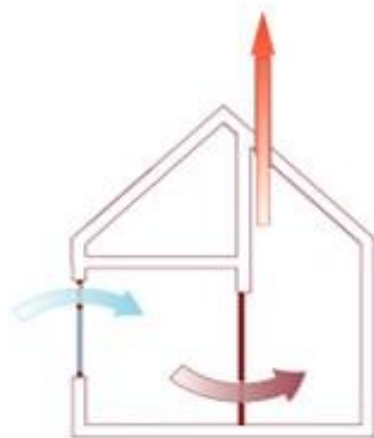

**stelsysteem A**

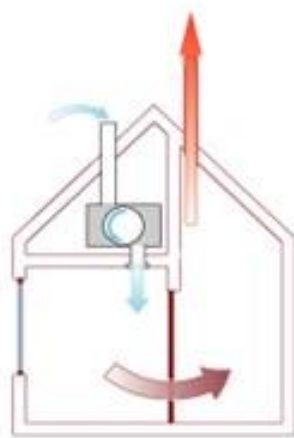

**stelsysteem B**

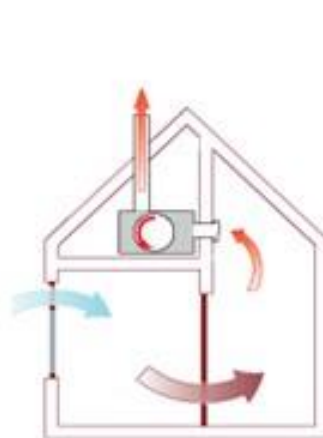

**stelsysteem C**

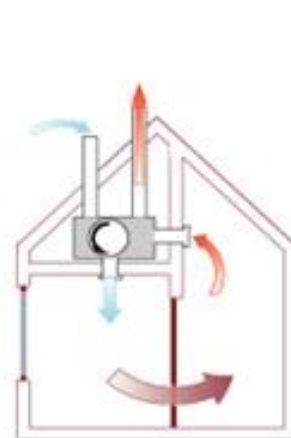

**stelsysteem D**

# Hoe ventileren

---

**Natuurlijk:**

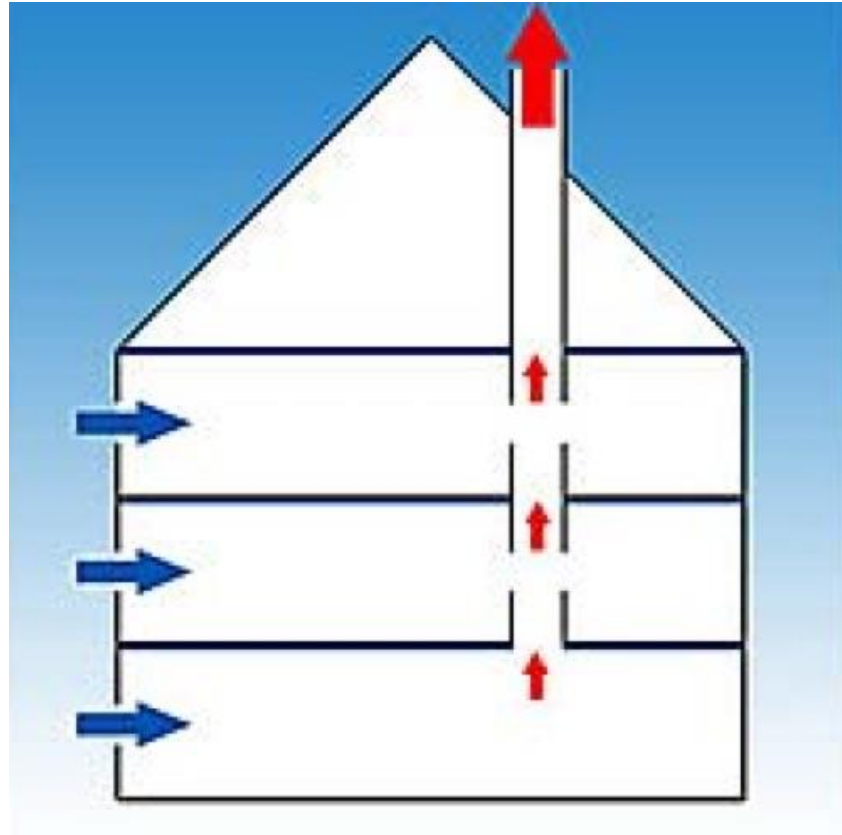

**Woning op onderdruk**

# Hoe ventileren

---

## Natuurlijk - Afvoer



# Hoe ventileren

---

## Natuurlijk - Toevoer



# Hoe ventileren

---

## Natuurlijk - Speciaal



# Hoe ventileren

## Natuurlijk + mechanisch:

A. Natuurlijke toevoer en mechanische afvoer (systeem C volgens de norm)

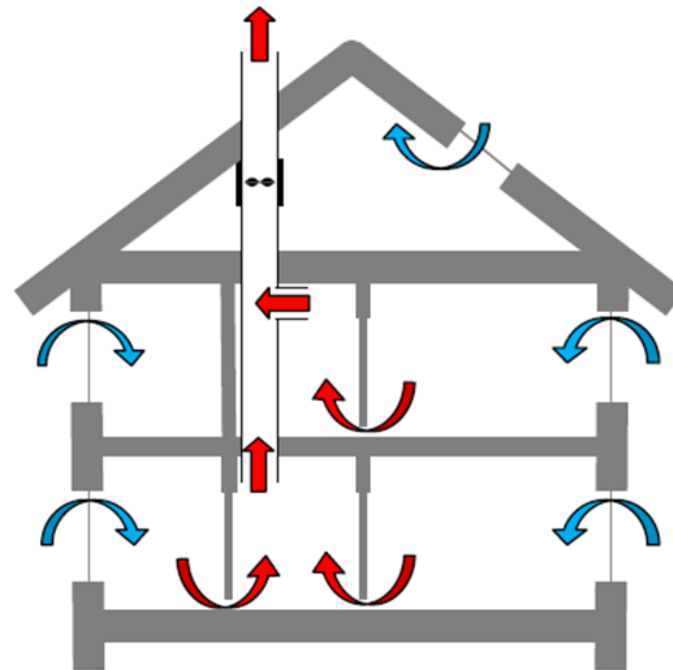

**Woning op onderdruk**

# Hoe ventileren

## Natuurlijk + mechanisch - afvoer

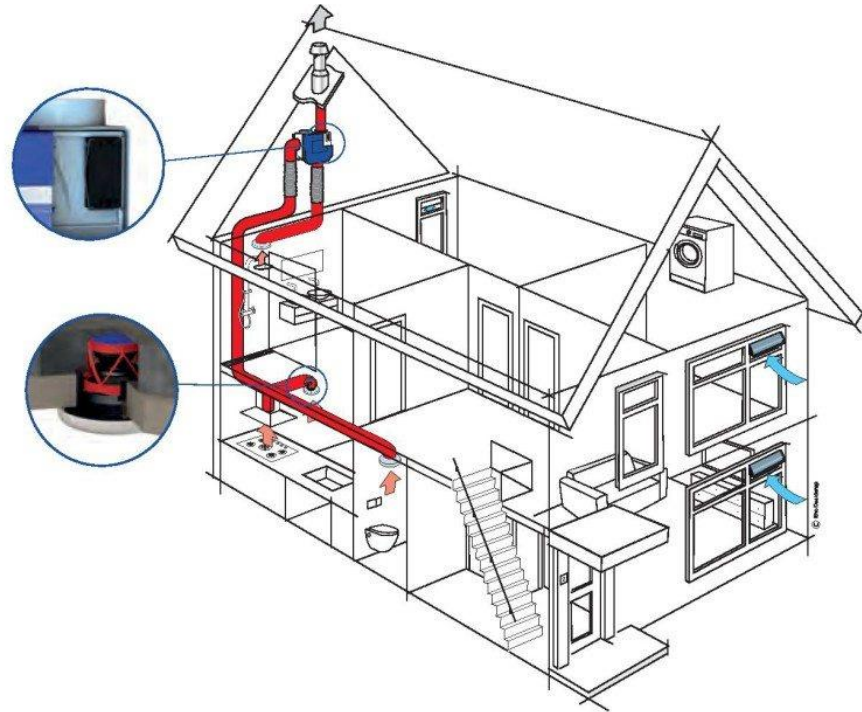

# Hoe ventileren

## Natuurlijk + mechanisch - afvoer



**Niet meer ventileren dan nodig is: vraag gestuurd**

# Hoe ventileren

## Natuurlijk + mechanisch - afvoer

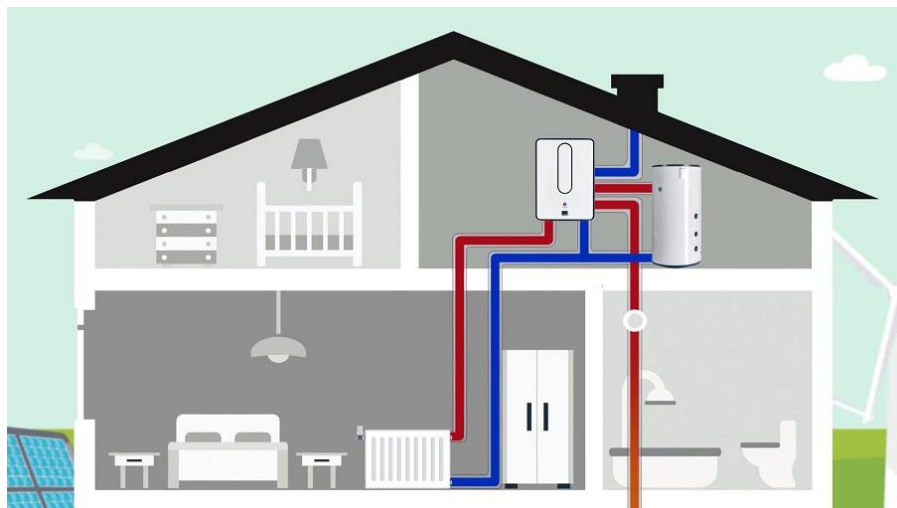

**ventilatiewarmtepomp**

**Warmte terugwinning: warm water**

# Hoe ventileren

## Mechanisch:

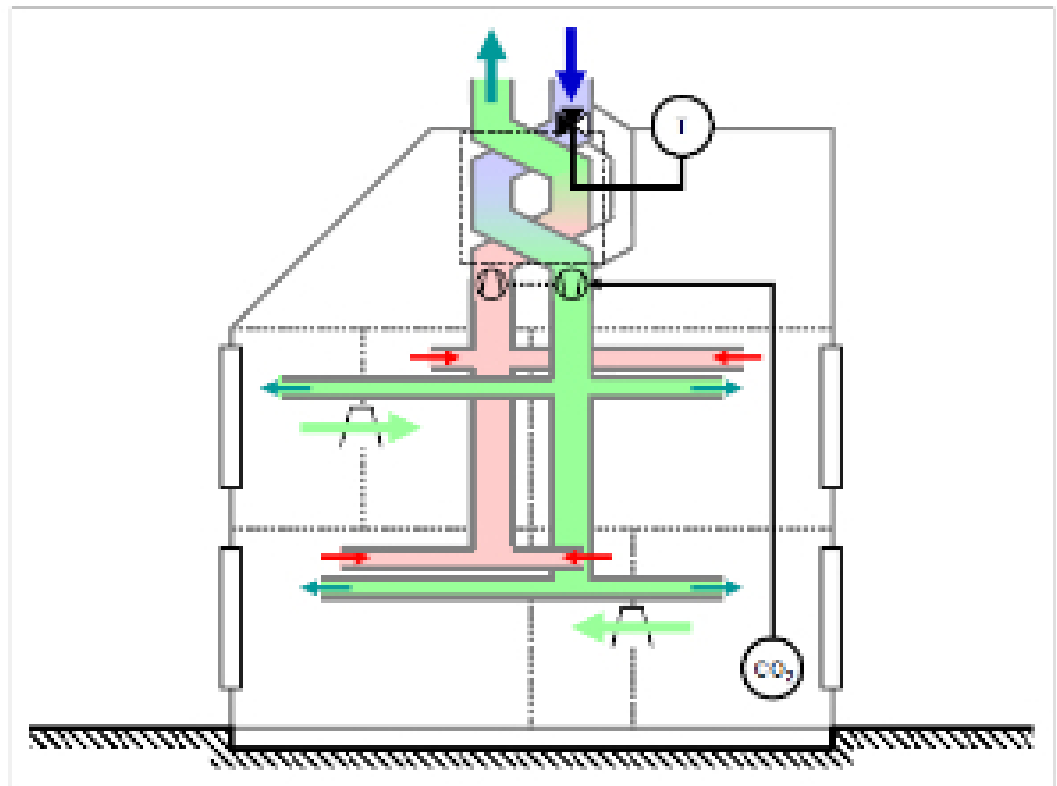

**Balansventilatie met warmte terugwinning (wtw)**

# Hoe ventileren

## Mechanisch:

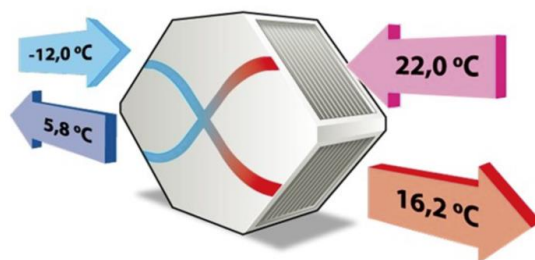

**Tegenstroom**

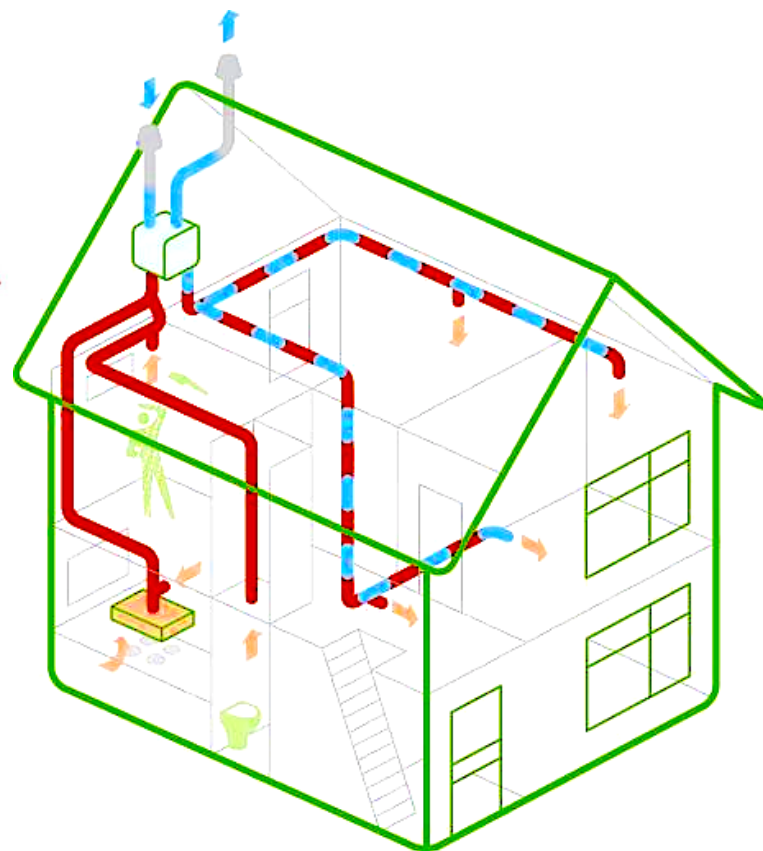

**Balansventilatie met warmte terugwinning (wtw)**

# Hoe ventileren

## Mechanisch - kanalen



# Hoe ventileren

---



## Systemen vergelijken:

	Natuurlijk	Hybride	Mechanisch
Controle	-	+	++
Hulpenergie	++	-	--
Energiebesparing	-	+	++
Geluid van buiten	-	-	+
Geluid installatie	+	-/+	-/++
Onderhoud	+	-	--

# Ventilatiesysteem in bestaande woningen

---

- **Multi Air Supply Systeem (Brink)**
- **Overflow systeem (Zehnder)**
- **Decentrale systemen**



# Ventilatiesysteem in bestaande woningen

- **Multi Air Supply System (Brink)**

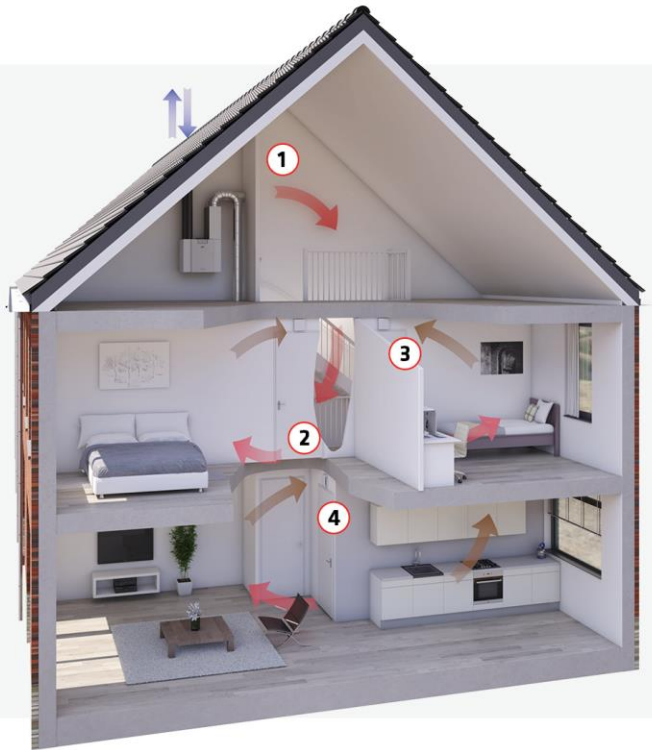

## HET MULTI AIR SUPPLY SYSTEEM STAP VOOR STAP

- 1** Middels een open toevoer brengt de WTW-unit verse lucht de trapkolom in.
- 2** Vanuit de overloop en hal verspreidt de verse lucht zich door de woning en via de deurspleet onder de binnendeur (2 cm) naar de verblijfsruimtes.
- 3** Boven de deur van de te ventileren ruimte is de Indoor Mixfan gemonteerd, standaard voorzien van CO<sub>2</sub>-sturing.
- 4** De Indoor Mixfan boven de deur zuigt vervuilde lucht af uit de verblijfsruimte. Bij een verhoogde concentratie CO<sub>2</sub> verhoogt ook de ventilatie.

→ Verse lucht  
← Vervuilde lucht

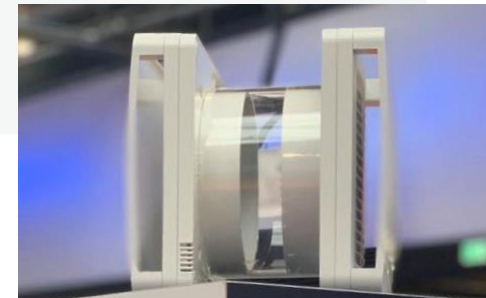

# Ventilatiesysteem in bestaande woningen

- Overflow systeem (Zehnder)

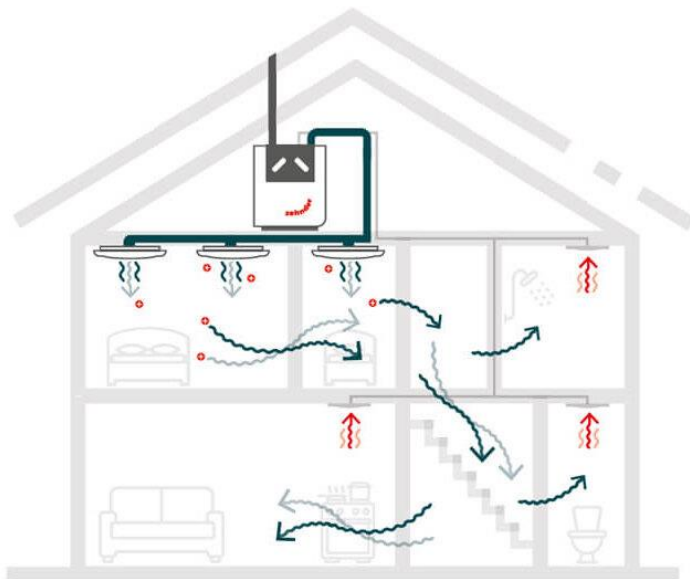

# Ventilatiesysteem in bestaande woningen

- Decentrale systemen



Ca. 70-100 m<sup>3</sup>/h



**Fresh-R**

# Ventilatie subsidie

---



- **RVO**
- **Gemeenten**
- **Warmtefonds**

# Ventilatieproject 2026

---



- In bestaande eigen woningen
- 2 centrale systemen met wtw (Brink en Zehnder)
- Gezamenlijke informatie
- Ventilatiescan bij je thuis
- Begeleiding offerte, realisatie en subsidie
- 1 jaar monitoring
- Begeleiding = gratis
- Zelf: investering (met collectiviteitskorting?)
- Tegenprestatie: voorbeeldproject

# Vragen

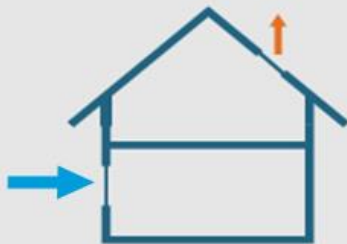

Natuurlijke ventilatie

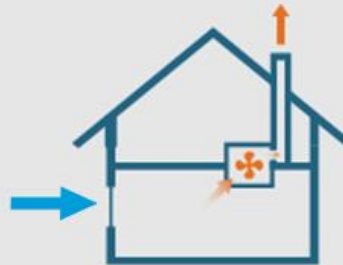

Natuurlijke toevoer  
& mechanische afvoer



Mechanische toevoer  
& afvoer

**Dank voor jullie aandacht**

***“THINK GLOBAL, ACT LOCAL”***